

STANLEY

GMT

www.gmt168.com.vn

KẸP KÍNH

PATCH FITTING

Tập hợp chức năng và trang trí thành một thể, áp dụng công nghệ đúc tiên tiến, sử dụng nắp đậy bên ngoài là thép không gỉ hoặc hợp kim nhôm chất lượng cao, chống cạy chống trộm.

Thông qua sự thử nghiệm 500.000 lần đóng mở, không có linh kiện hư hỏng và vẫn giữ được chức năng tốt.

Thông qua thử nghiệm của Trung tâm kiểm nghiệm Trung Quốc.

Thích hợp dùng cho các nơi trung & cao cấp.

Thích hợp dùng với kính dày 12, 15, 19 mm và các kính trang trí, bền bỉ chắc chắn.

With Great Function & Nice Shape.

Perfectly Fit Into The Decoration.

To adopt the advanced die-casting technology.

To use high grade stainless steel or aluminum alloy cover.

Anti-burglary. After 500.000 cycle time test, there is barely any damage of the parts and still function in good condition. We have the reward from china's authorities.

Suitable for glass thickness : 12, 15, 19 mm

KỆ KÍNH PATCH FITTING

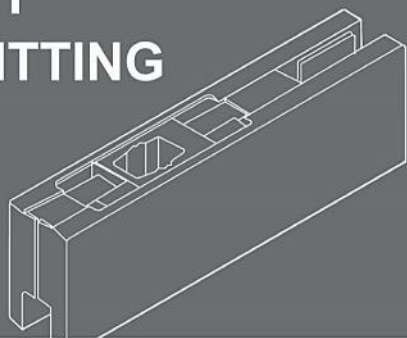

- Bề mặt bóng : US26
Polished
- Bề mặt mờ : US15
Satin
- Độ dày kính thích hợp : 10 ~ 12 mm
Glass Thickness
- Chiều rộng cửa thích hợp : < 1200 mm
Door Width



PFC-010

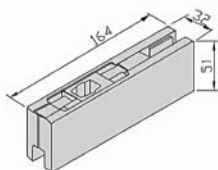

PFC-020

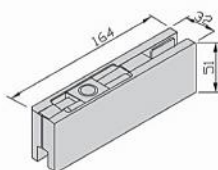

PFC-030

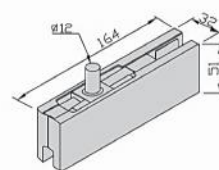

PFC-034

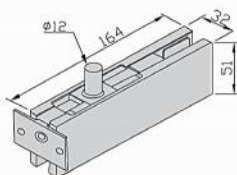

PFC-040

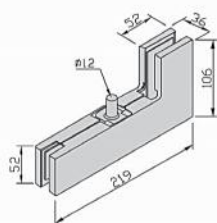

PFC-041R/L

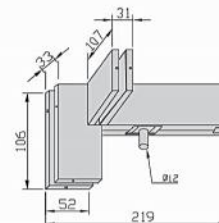

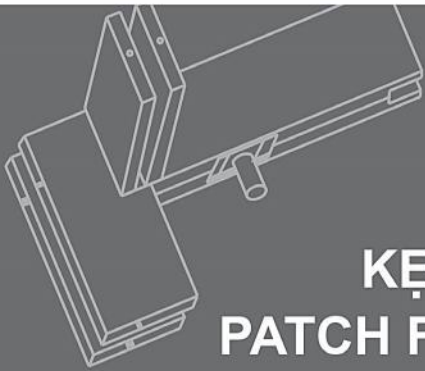

KỆ KÍNH PATCH FITTING

- Bề mặt bóng : US26
Polished
- Bề mặt mờ : US15
Satin
- Độ dày kính thích hợp : 10 ~ 12 mm
Glass Thickness
- Chiều rộng cửa thích hợp : < 1200 mm
Door Width



PFC-051

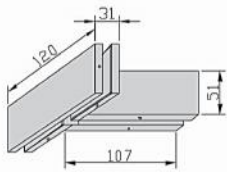

PFC-052

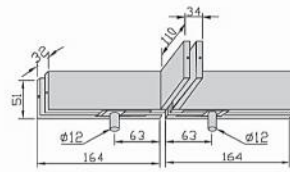

PFC-060

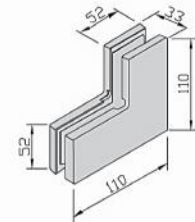

PUS-010

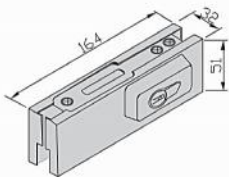

PFR/L-S010

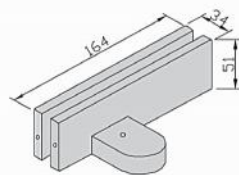

PFR/L-020

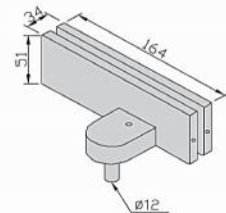

SƠ ĐỒ LẮP RÁP KỆ KÍNH

Bản lề sàn Floor Hinge

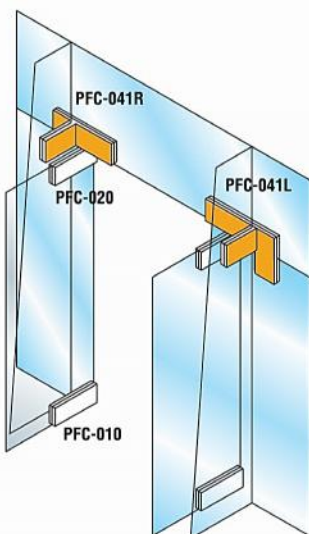
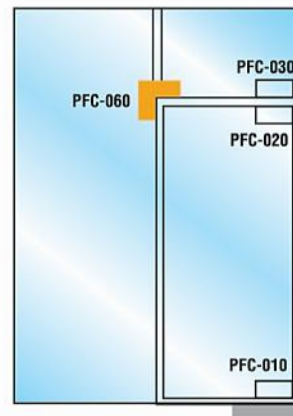
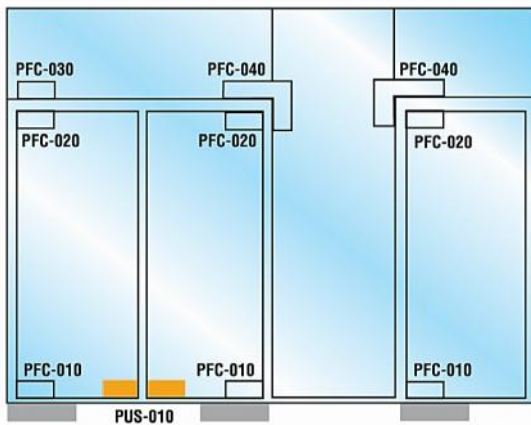
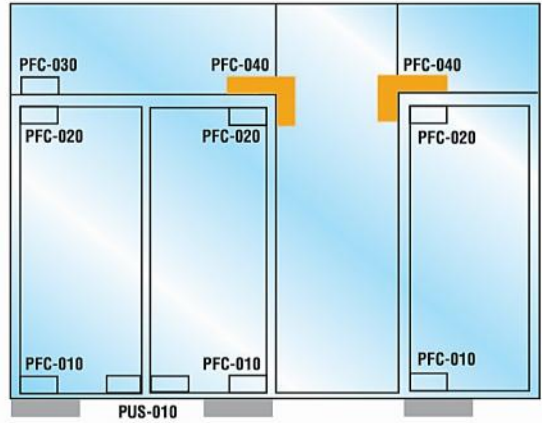
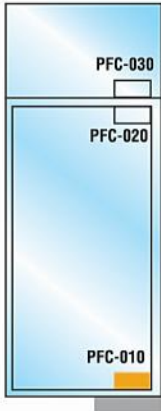

PFC-041R/L

Phối hợp sử dụng với PFC-020
(To use with PFC-020)

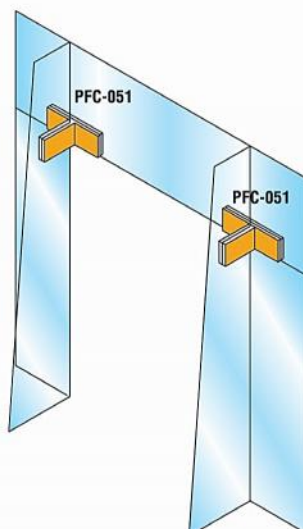

PFC-051

Chỉ có chức năng cố định
(Fixing Glasses only)

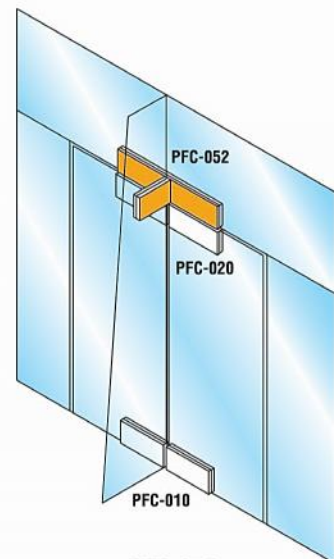

PFC-052

Phối hợp sử dụng với PFC-020
(To use with PFC-020)